

CATERLUX
Live an illuminated life



Hanger series



About us

Ever since Caterlux's inception in 2016, we have been working hard towards lighting up your homes with avant-garde quality products and exceptional service. We specialize in providing energy efficient lighting solutions and LED to our customers. Caterlux's lighting solutions add value to space be it office or home. Our lighting solutions are paving the way towards a brighter future with the combination of design and innovation. Providing quality lighting with minimal cost is what Caterlux firmly believes in.

From initial consultation to designs and conceptualization to delivering premium quality and even custom-made lighting solutions, there's nothing we don't do. All our lighting products meet the highest quality standards and are designed to give our customers absolute value for money.

Ensuring you with select, high end illumination products, we stand behind our work and guarantee the most stringent quality assurances. Caterlux lighting strives to bring to our customers lighting solutions that strike the perfect balance between quality, reliability and style.

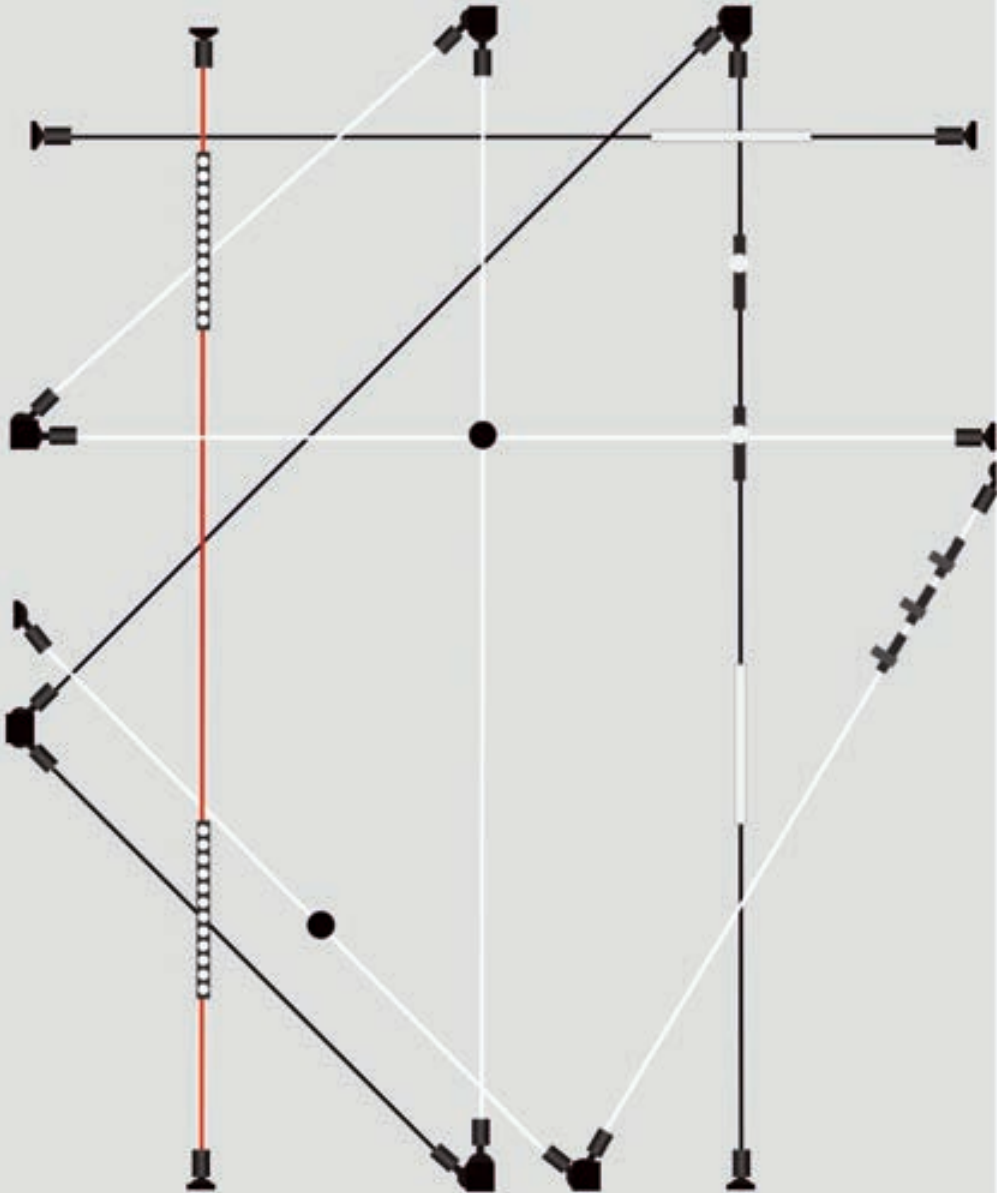

Hanger series Track



CTR-GD1811D/L1000/T

Hanger series Combination lamps

Spotlight



CTR-SD2265T/3W



CTR-SD3463T/5W



CTR-SD34100T/8W

Grille Linear Light



CTR-GSD3660T/L284/7W

Flat Linear Light



CTR-PMD3660T/L313/8W



Flexible track

Flexible track

Flexible track is the latest work of Mitani R & D team, which integrates track and flexible luminous body, and further improves the technology, bringing you a more free lighting experience. With four tracks of different sizes and Available in red, white and black, the Barney series provides flexible and detailed lighting needs for different space environments

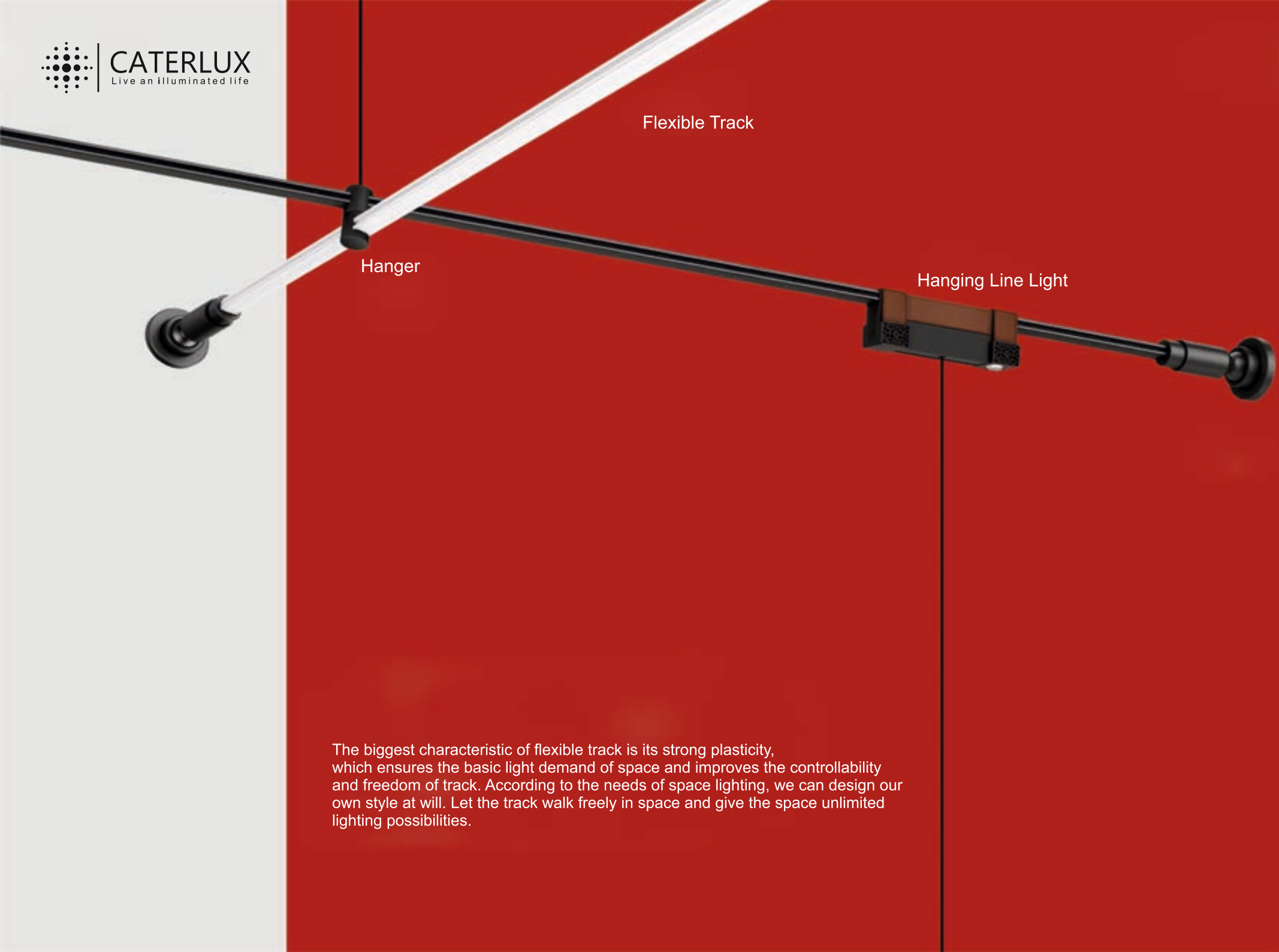

Flexible Track

Hanger

Hanging Line Light

The biggest characteristic of flexible track is its strong plasticity, which ensures the basic light demand of space and improves the controllability and freedom of track. According to the needs of space lighting, we can design our own style at will. Let the track walk freely in space and give the space unlimited lighting possibilities.

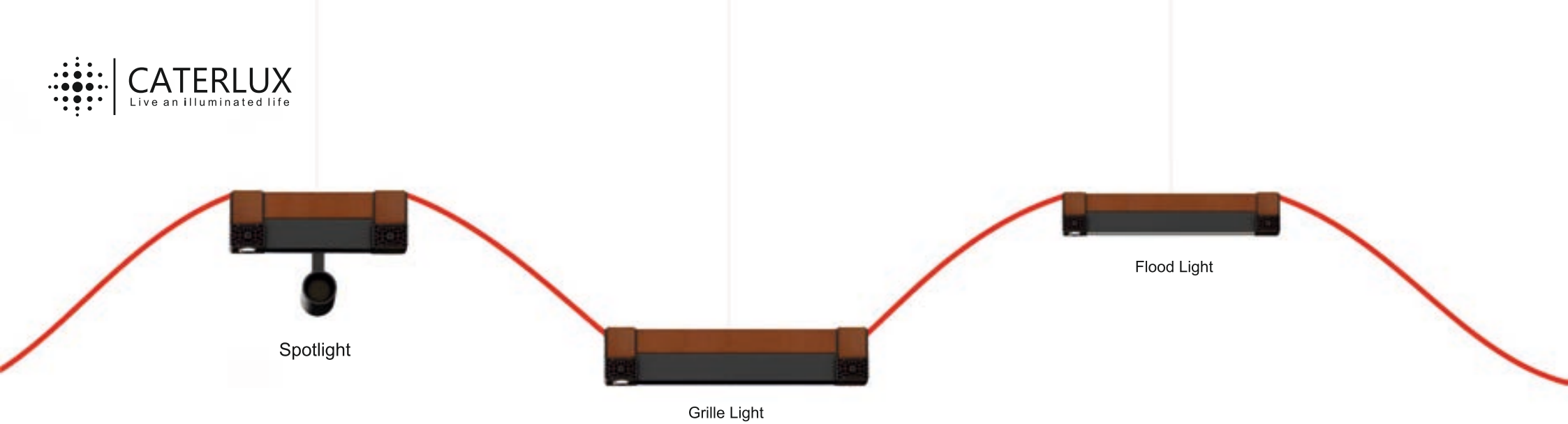

DC24V safety rail

The installation of Bani series lamp module is very simple and convenient; The safety voltage of 24V is adopted, which can be touched after being electrified, and the mechanical buckle type and belt button type double fixation are adopted, so that the working stability of the lamp is ensured, the service life is prolonged, and the safety of the lamp in the process of installation, disassembly and maintenance is guaranteed

Multi-angle connection lighting direction free
rotation angle adjustment free installation

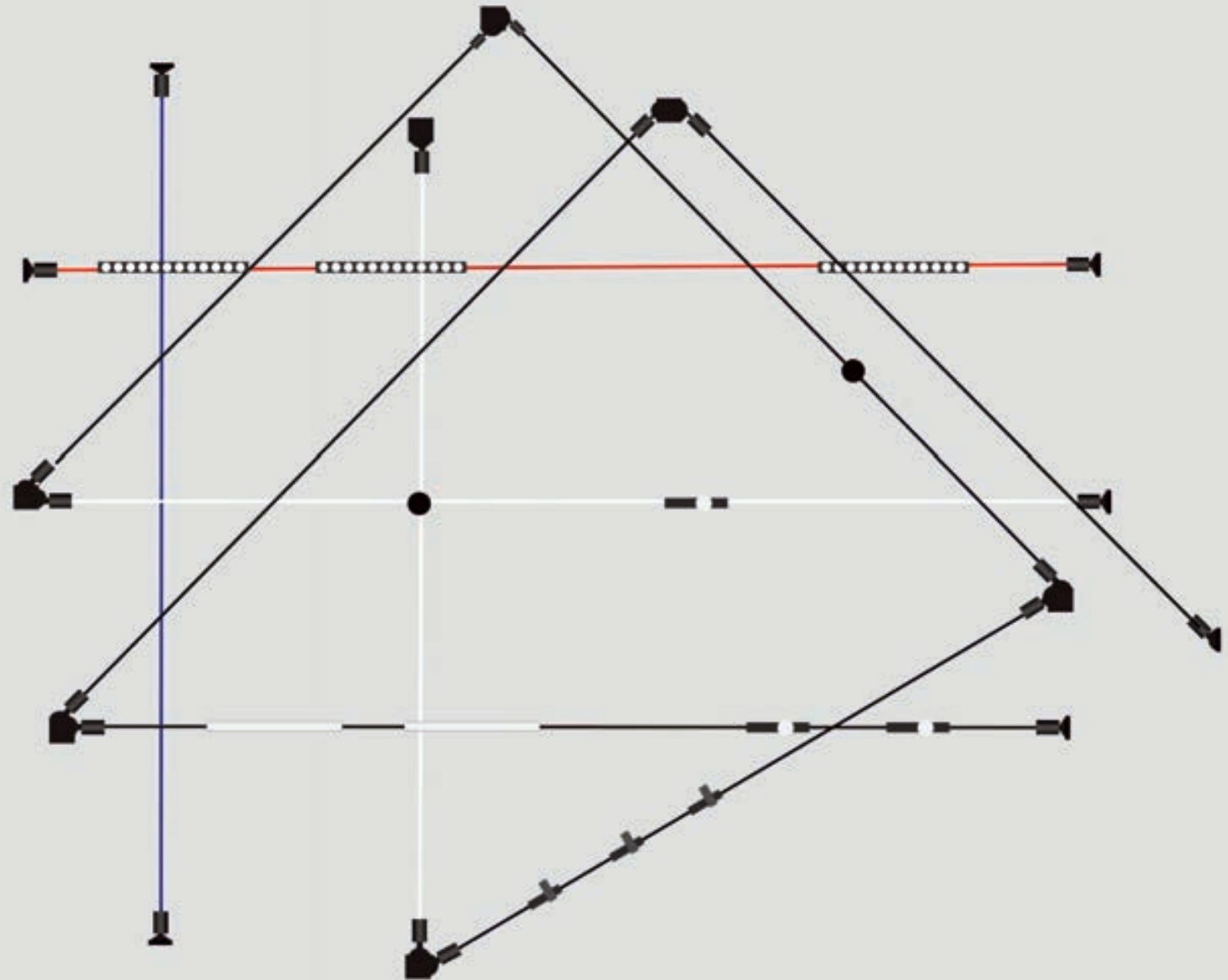

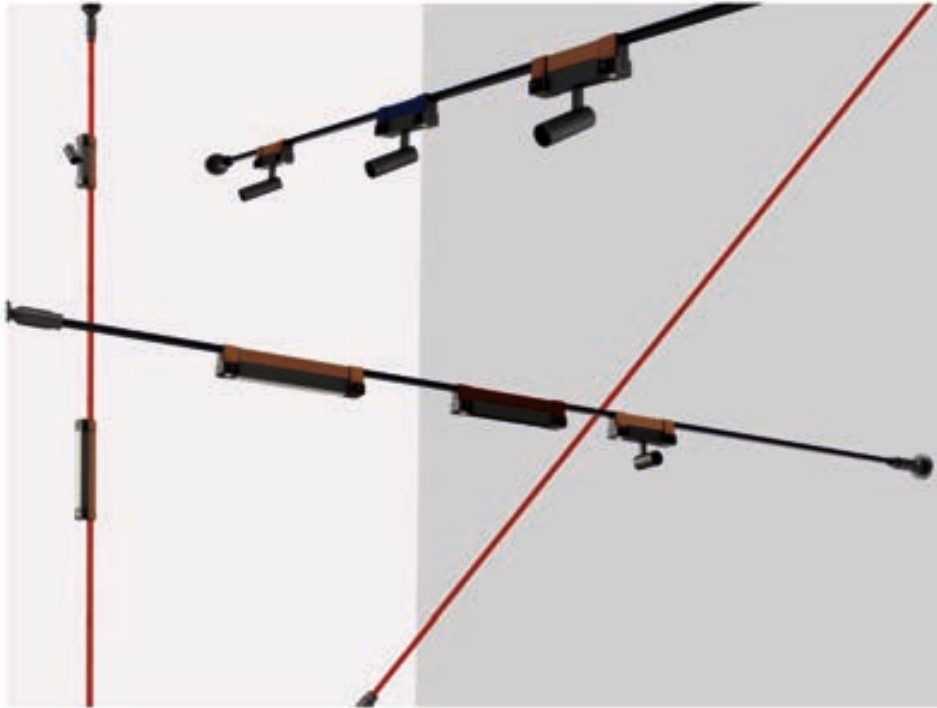

1. Space Light & shadow

Leaving only light from the walls to the ceiling, The base can be adjusted up and down by 70 degrees and is convenient to install, and is suitable for diversified spaces such as special - shaped spaces, domes and the like it has both functional and artistic lighting, reshaping space light and shadow and bringing more possibilities for interior space and lighting design.

2. Flexible changes

Barney series links the ceiling and wall has a strong orientation, can also increase lighting at will, has a sense of freshness and design, can be called modular design, traditional magnetic attraction lamp, Barney series can meet Comprises magnetic suction tube lamp, a spotlight a grid lamp, a floodlight strip and a pendant lamp, installation is simple, you can match at will.

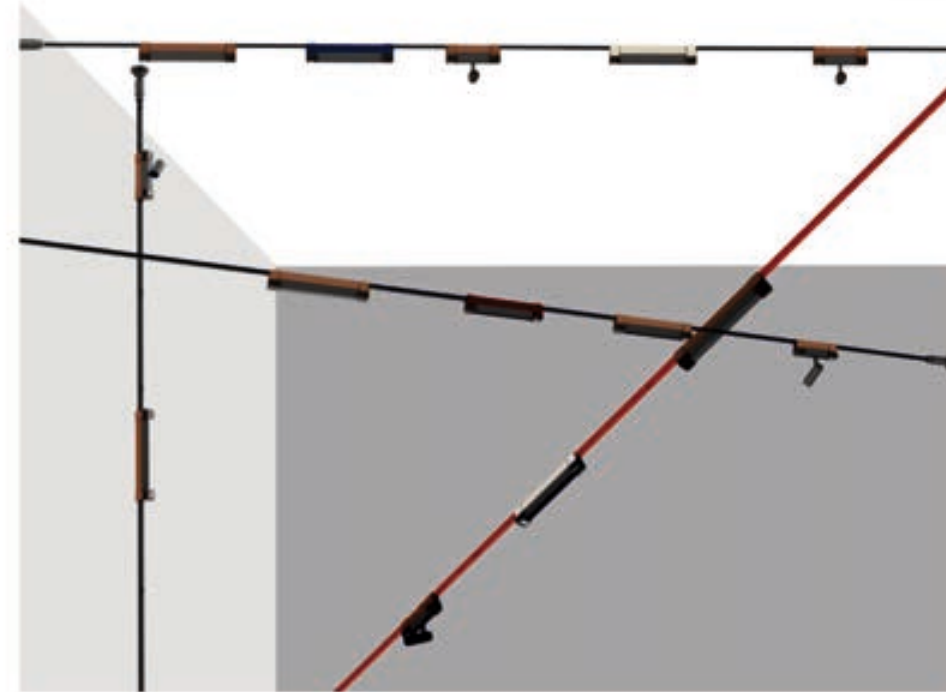

3. Easy to install

Barney series abandoned the super fluous and exaggerated shape, re-deconstructed the shape of the lamp, flexible use, it can be arbitrarily cut according to the size of the venue custom size Multi-angle connection, free rotation and adjustment of lighting direction free angle and easy installation.

4. Versatile scenes

Return to the essence of the charm of streamline lighting minimalist shape. Applicable to art galleries, art galleries, clubs, villas, exhibition halls, commercial space, office space design studios, furnishings spaces.

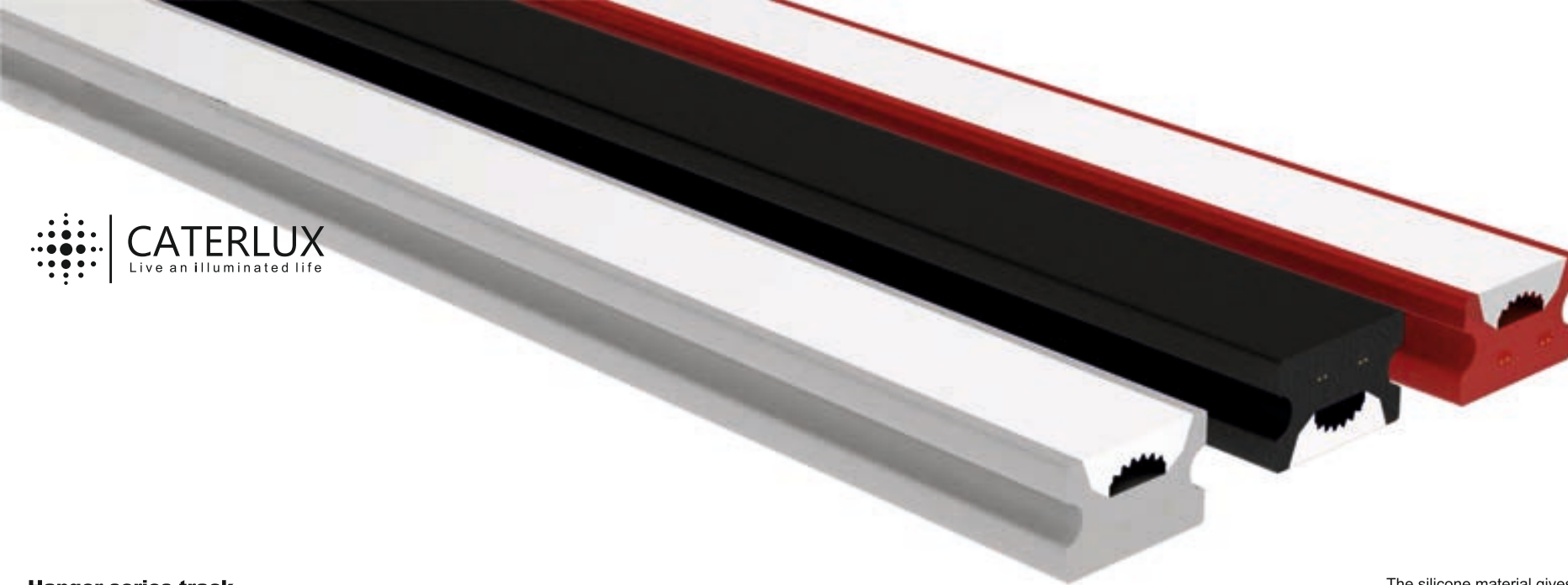

Hanger series track

- Product model : CTR-GD1811D/L1000/T
- Installation method : ceiling type
- Product size : W18*H11mm
- Standard specifications: L1000/1500/2000mm
- Control method : multiple groups of control
- Material : 6063 aluminum
- Appearance color : black/white/red
- Protection level : IP20

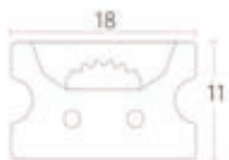

The silicone material gives it the ability to twist

1.8cm width makes it light and compact
The combination of the two makes the design ever-changing and strange.

Applicable accessories

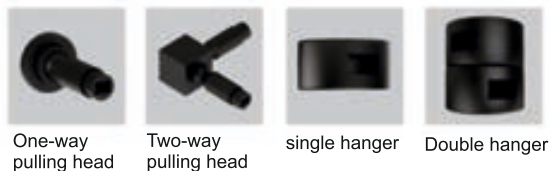

Applicable Lamps

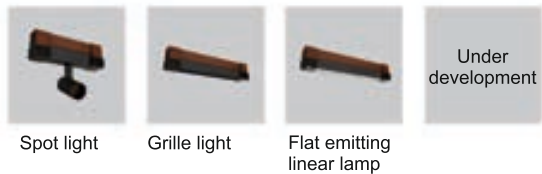

Various shapes

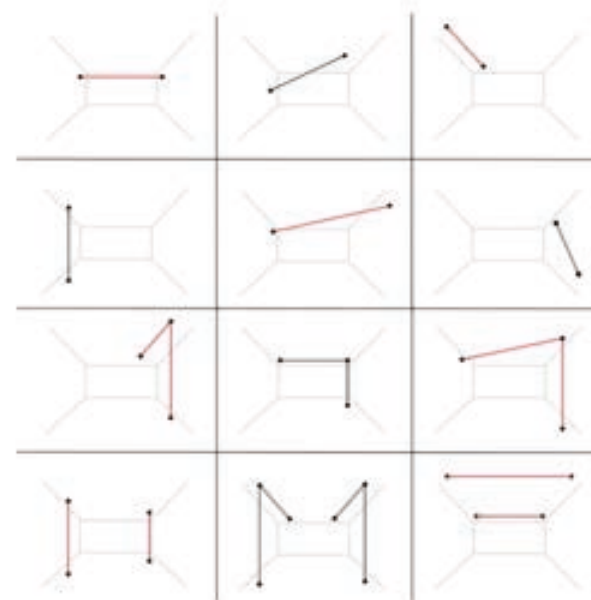

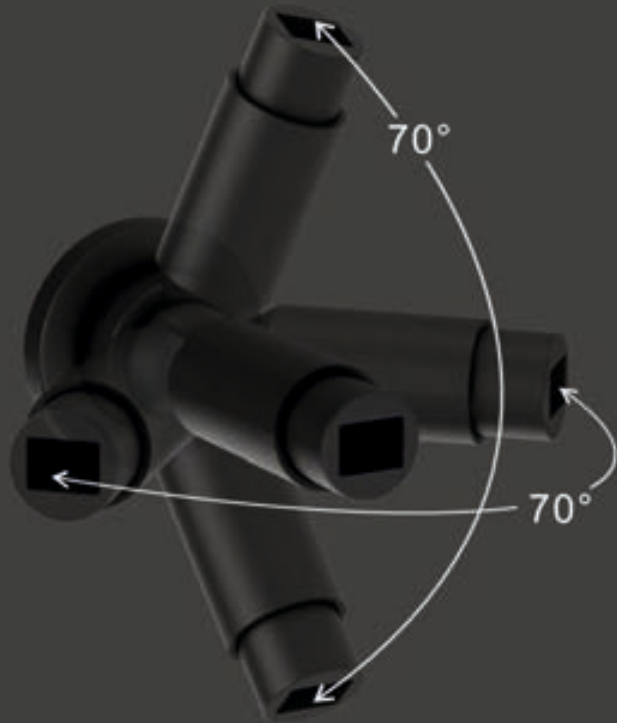

In adjustable angle with in the range,
the angle can be adjusted any direction

Tension head

Name	Size	Colour
Two-way pulling head	Ø67*123	Black



Name	Size	Colour
Two-way pulling head	Ø60*113	Black

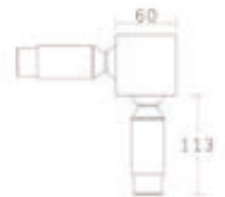
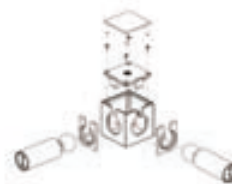

Hanger

Name	Size	Colour
Single hanger	ø20*15	Black



Name	Size	Colour
Double hanger	ø20*30	Black



Note : If the track exceeds 3 meters, you need to use a hanger to assist in straightening the track.
You can also choose it yourself within 3 meters.

Strength "two sides"

Arrange light strips on the top, and place them on the bottom

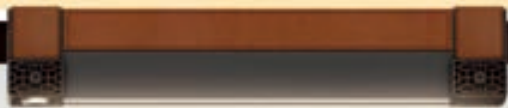



Contact surface conductive pins
Belt locking light fixtures



Product size (mm):

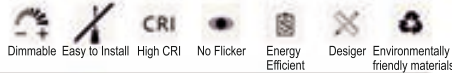

Control System

- ON/OFF
- 0-10V
- DALI dimming control system
- SCR control system
- Other dimming control systems

Hanger Series Spotlights

Optical parameters

Beam angle	15°			24°			38°		
	Beam diameter (mm)	Beam diameter (mm)	Beam diameter (mm)	Beam diameter (mm)	Beam diameter (mm)	Beam diameter (mm)	Beam diameter (mm)	Beam diameter (mm)	Beam diameter (mm)
Luminous flux	248.0 lm	248.0 lm	248.0 lm	248.0 lm	248.0 lm	248.0 lm	248.0 lm	248.0 lm	248.0 lm
Illumination distance relationship	0.5m 1.0m 1.5m	0.5m 1.0m 1.5m	0.5m 1.0m 1.5m	0.5m 1.0m 1.5m	0.5m 1.0m 1.5m	0.5m 1.0m 1.5m	0.5m 1.0m 1.5m	0.5m 1.0m 1.5m	0.5m 1.0m 1.5m
Light intensity distribution curve (unit: cd)									
CO/C180:	—								
C90/C270:	—								

- Product model : CTR-SD2265T/3W
- Product size : Ø22*L65mm
- Material : 6063 aluminum
- Appearance color : Royal blue/vit orange/burgundy/off-white
- Protection level : IP20
- Dimming : Support
- Light source : Osram
- Voltage : DC24V
- Power : 3W
- Color temperature: 2700K/3000K/4000K
- CRI : ≥90
- Beam angle : 15°/24°/38°

Color temperature comparison legend

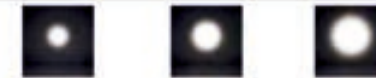

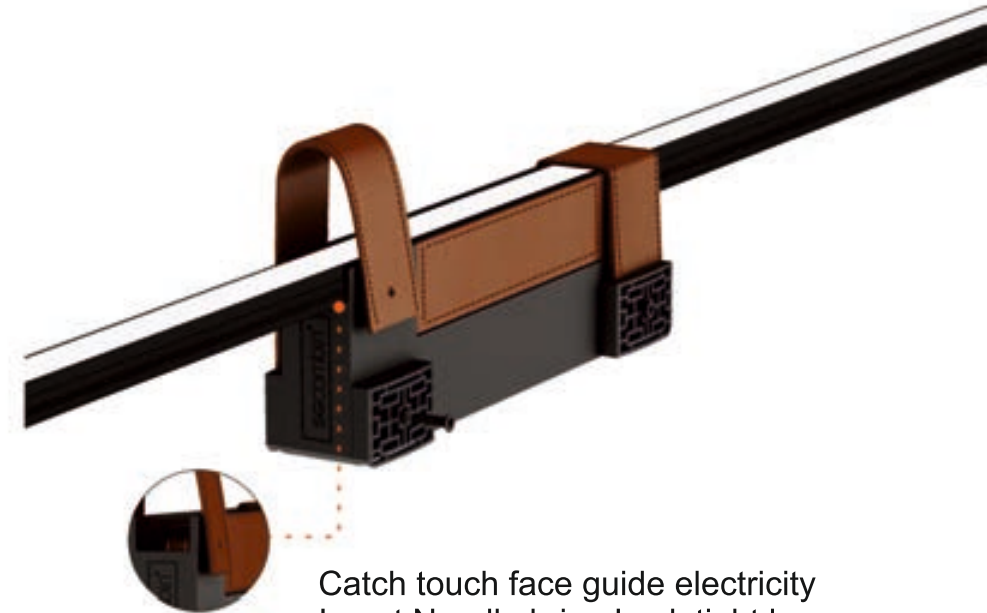

Catch touch face guide electricity
Insert Needle bring Lock tight lamps

Product size (mm):

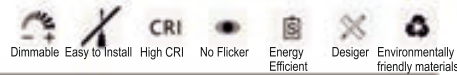
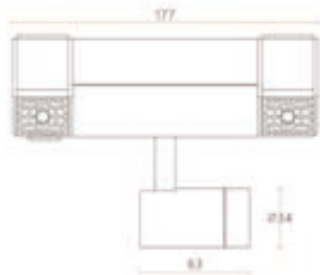







Control System

- ON/OFF
- 0-10V
- DALI dimming control system
- SCR control system
- Other dimming control systems

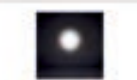
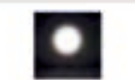
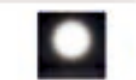
Hanger Series Spotlights

Optical parameters

Beam angle	15°	24°	38°																																																												
Luminous flux	148.2lm	402.0lm	238.5lm																																																												
Illumination distance relationship	<table border="1"> <tr><th>Name</th><th>0.5m</th><th>1m</th><th>1.5m</th></tr> <tr><td>Beam diameter</td><td>1.5m</td><td>3.0m</td><td>4.5m</td></tr> <tr><td>Beam diameter</td><td>2.25m</td><td>4.5m</td><td>6.75m</td></tr> <tr><td>Beam diameter</td><td>3.38m</td><td>6.75m</td><td>10.13m</td></tr> <tr><td>Beam diameter</td><td>5.0m</td><td>10.13m</td><td>15.19m</td></tr> </table>	Name	0.5m	1m	1.5m	Beam diameter	1.5m	3.0m	4.5m	Beam diameter	2.25m	4.5m	6.75m	Beam diameter	3.38m	6.75m	10.13m	Beam diameter	5.0m	10.13m	15.19m	<table border="1"> <tr><th>Name</th><th>0.5m</th><th>1m</th><th>1.5m</th></tr> <tr><td>Beam diameter</td><td>1.5m</td><td>3.0m</td><td>4.5m</td></tr> <tr><td>Beam diameter</td><td>2.25m</td><td>4.5m</td><td>6.75m</td></tr> <tr><td>Beam diameter</td><td>3.38m</td><td>6.75m</td><td>10.13m</td></tr> <tr><td>Beam diameter</td><td>5.0m</td><td>10.13m</td><td>15.19m</td></tr> </table>	Name	0.5m	1m	1.5m	Beam diameter	1.5m	3.0m	4.5m	Beam diameter	2.25m	4.5m	6.75m	Beam diameter	3.38m	6.75m	10.13m	Beam diameter	5.0m	10.13m	15.19m	<table border="1"> <tr><th>Name</th><th>0.5m</th><th>1m</th><th>1.5m</th></tr> <tr><td>Beam diameter</td><td>1.5m</td><td>3.0m</td><td>4.5m</td></tr> <tr><td>Beam diameter</td><td>2.25m</td><td>4.5m</td><td>6.75m</td></tr> <tr><td>Beam diameter</td><td>3.38m</td><td>6.75m</td><td>10.13m</td></tr> <tr><td>Beam diameter</td><td>5.0m</td><td>10.13m</td><td>15.19m</td></tr> </table>	Name	0.5m	1m	1.5m	Beam diameter	1.5m	3.0m	4.5m	Beam diameter	2.25m	4.5m	6.75m	Beam diameter	3.38m	6.75m	10.13m	Beam diameter	5.0m	10.13m	15.19m
Name	0.5m	1m	1.5m																																																												
Beam diameter	1.5m	3.0m	4.5m																																																												
Beam diameter	2.25m	4.5m	6.75m																																																												
Beam diameter	3.38m	6.75m	10.13m																																																												
Beam diameter	5.0m	10.13m	15.19m																																																												
Name	0.5m	1m	1.5m																																																												
Beam diameter	1.5m	3.0m	4.5m																																																												
Beam diameter	2.25m	4.5m	6.75m																																																												
Beam diameter	3.38m	6.75m	10.13m																																																												
Beam diameter	5.0m	10.13m	15.19m																																																												
Name	0.5m	1m	1.5m																																																												
Beam diameter	1.5m	3.0m	4.5m																																																												
Beam diameter	2.25m	4.5m	6.75m																																																												
Beam diameter	3.38m	6.75m	10.13m																																																												
Beam diameter	5.0m	10.13m	15.19m																																																												
Light intensity distribution curve (unit: cd)																																																															
CO/C180: —																																																															
C90/C270: —																																																															

Product model : CTR-SD3463T/5W
 Product size : Ø34*L63mm
 Material : 6063 aluminum
 Appearance color : Royal blue/vital orange/burgundy/off-white
 Protection level : IP20
 Dimming : Support
 Light source : Osram
 Voltage : DC24V
 Power : 5W
 Color temperature: 2700K/3000K/4000K
 CRI : ≥90
 Beam angle : 15°/24°/38°

Color temperature comparison legend



2700K 3000K 4000K



Product size (mm):

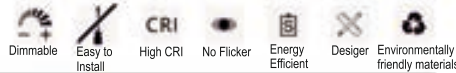
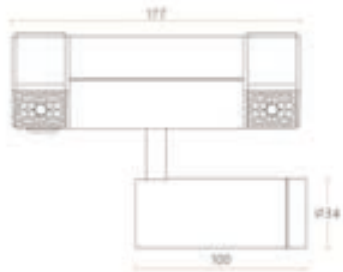

Control System

- ON/OFF
- 0-10V
- DALI dimming control system
- SCR control system
- Other dimming control systems

Hanger Series Spotlights

Optical parameters

Beam angle	15°	24°	38°																																																												
Luminous flux	563.5lm	484.4lm	339.7lm																																																												
Illumination distance relationship	<table border="1"> <tr><th>Height</th><th>Ø15°</th><th>Ø24°</th><th>Ø38°</th></tr> <tr><td>1.5m</td><td>102.3</td><td>63.7</td><td>39.6</td></tr> <tr><td>2.25</td><td>153.4</td><td>95.5</td><td>59.4</td></tr> <tr><td>3.0m</td><td>204.6</td><td>134.3</td><td>89.1</td></tr> <tr><td>4.5m</td><td>306.9</td><td>201.5</td><td>133.7</td></tr> </table>	Height	Ø15°	Ø24°	Ø38°	1.5m	102.3	63.7	39.6	2.25	153.4	95.5	59.4	3.0m	204.6	134.3	89.1	4.5m	306.9	201.5	133.7	<table border="1"> <tr><th>Height</th><th>Ø15°</th><th>Ø24°</th><th>Ø38°</th></tr> <tr><td>1.5m</td><td>68.2</td><td>42.5</td><td>26.4</td></tr> <tr><td>2.25</td><td>102.3</td><td>63.7</td><td>39.6</td></tr> <tr><td>3.0m</td><td>136.4</td><td>95.5</td><td>59.4</td></tr> <tr><td>4.5m</td><td>204.6</td><td>134.3</td><td>89.1</td></tr> </table>	Height	Ø15°	Ø24°	Ø38°	1.5m	68.2	42.5	26.4	2.25	102.3	63.7	39.6	3.0m	136.4	95.5	59.4	4.5m	204.6	134.3	89.1	<table border="1"> <tr><th>Height</th><th>Ø15°</th><th>Ø24°</th><th>Ø38°</th></tr> <tr><td>1.5m</td><td>22.7</td><td>14.2</td><td>9.1</td></tr> <tr><td>2.25</td><td>34.1</td><td>21.3</td><td>13.7</td></tr> <tr><td>3.0m</td><td>45.4</td><td>28.4</td><td>18.2</td></tr> <tr><td>4.5m</td><td>68.2</td><td>42.5</td><td>26.4</td></tr> </table>	Height	Ø15°	Ø24°	Ø38°	1.5m	22.7	14.2	9.1	2.25	34.1	21.3	13.7	3.0m	45.4	28.4	18.2	4.5m	68.2	42.5	26.4
Height	Ø15°	Ø24°	Ø38°																																																												
1.5m	102.3	63.7	39.6																																																												
2.25	153.4	95.5	59.4																																																												
3.0m	204.6	134.3	89.1																																																												
4.5m	306.9	201.5	133.7																																																												
Height	Ø15°	Ø24°	Ø38°																																																												
1.5m	68.2	42.5	26.4																																																												
2.25	102.3	63.7	39.6																																																												
3.0m	136.4	95.5	59.4																																																												
4.5m	204.6	134.3	89.1																																																												
Height	Ø15°	Ø24°	Ø38°																																																												
1.5m	22.7	14.2	9.1																																																												
2.25	34.1	21.3	13.7																																																												
3.0m	45.4	28.4	18.2																																																												
4.5m	68.2	42.5	26.4																																																												
Light intensity distribution curve (unit: cd)																																																															
C0/C180:	—	—	—																																																												
C90/C270:	—	—	—																																																												

Product model : CTR-SD34100T/8W
 Product size : Ø34*L100mm
 Material : 6063 aluminum
 Appearance color : Royal blue/vital orange/burgundy/off-white
 Protection level : IP20
 Dimming : Support
 Light source : Osram
 Voltage : DC24V
 Power : 8W
 Color temperature: 2700K/3000K/4000K
 CRI : ≥90
 Beam angle : 15°/24°/38°



Color temperature comparison legend





Vibrant Orange



White color



Royal blue



Burgundy color

Product size (mm):



Control System

- ON/OFF
- 0-10V
- DALI dimming control system
- SCR control system
- Other dimming control systems

Hanger Series Grille linear light

Optical parameters

Beam angle : 25°

Luminous flux : 206.2lm

Illumination distance relationship



Light intensity distribution curve (unit: cd)

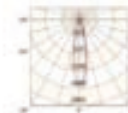

CO/C180: —
C90/C270: —



Product model : CTR-GSD3660T/L284/7W
 Product size : L284*W36*H60mm
 Material : 6063 aluminum
 Appearance color : Royal blue/vivid orange/burgundy/white
 Protection level : IP20
 Dimming : Support
 Light source : Osram
 Voltage : DC24V
 Power : 7W
 Color temperature: 2700K/3000K/4000K
 CRI : ≥90
 Beam angle : 25°

Color temperature comparison legend



2700K 3000K 4000K



Product size (mm):

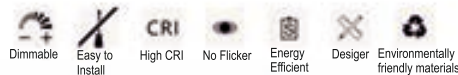

Control System

- ON/OFF
- 0-10V
- DALI dimming control system
- SCR control system
- Other dimming control systems

Hanger series flat glow linear lamp

Optical parameters

Beam angle : 100°

Luminous flux : 367.2lm

Height (m)	Beam diameter (m)	Illuminance (lx)
1.50	0.54	9.94
3.00	1.08	2.48
4.50	1.62	1.65

Light intensity distribution curve (unit: cd)

CO/C180: —

C90/C270: —

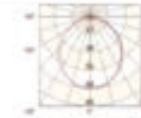

Product model : CTR-PMD360T/L313/8W
 Product size : L313*W36*H60mm
 Material : 6063 aluminum
 Appearance color : royal blue/vital orange/burgundy/off-white
 Protection level : IP20
 Dimming : Support
 Light Source : Osram
 Voltage : DC24
 Power : 8W
 Color temperature : 2700K/3000K/4000K
 CRI : >90
 Beam angle : 100°

Color temperature comparison legend

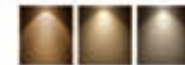

2700K 3000K 4000K

Hanger series accessories

Choose freely according to the actual situation



Overtake

BEYOND FREEDOM



JUST IMAGINE



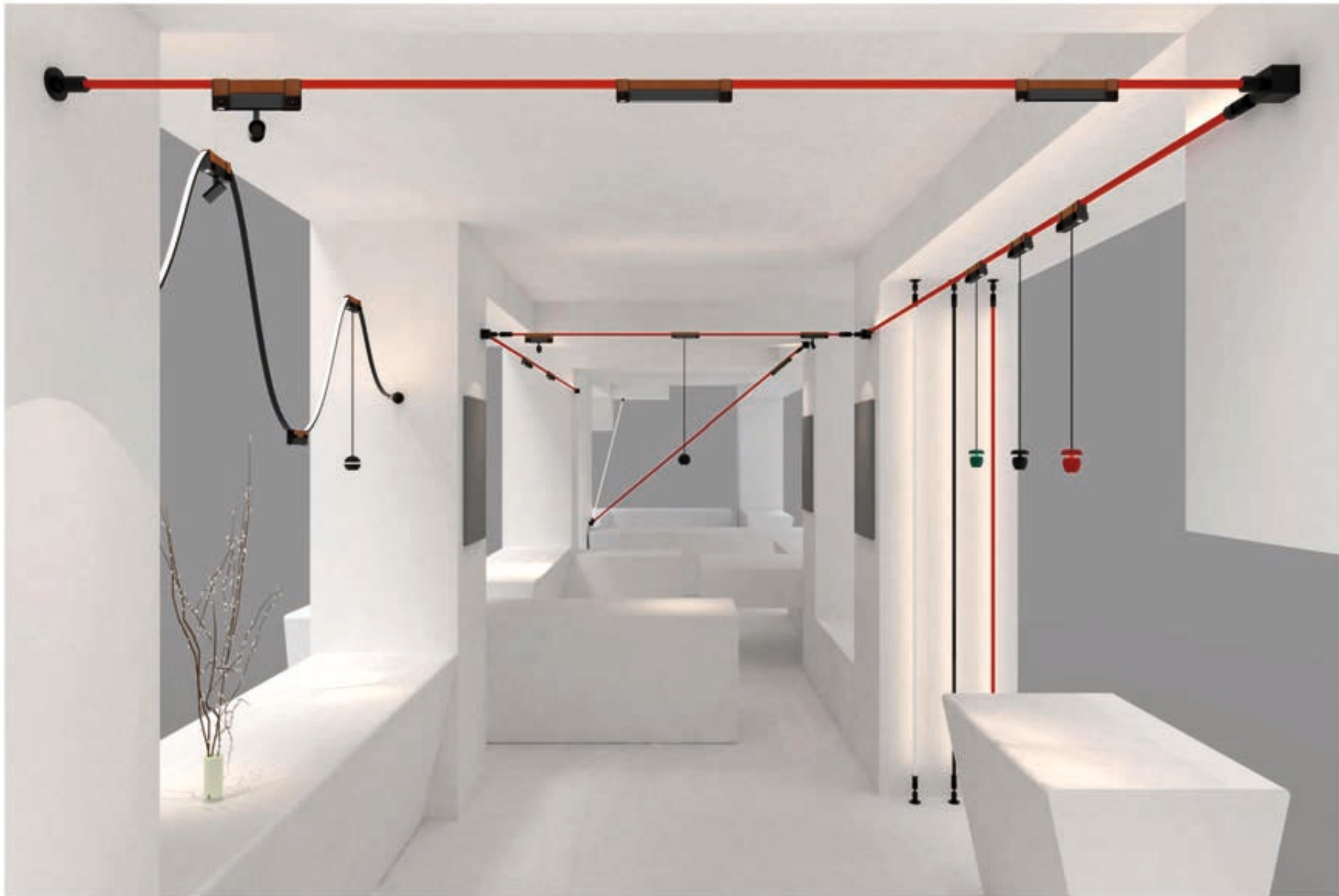



**Solve the problem of floor height and
achieve diversified lighting**

The criss-crossing lines cast light and shadow magic
Gives a sense of smart beaut





Now generation simple clean Wire strip of beautiful

Can by extend stretch out many kind make type
 let Light film play interpret individual
 sex of art technique null between

**For null between increase add art technique
feel and high class feel**

spirit move and light surplus of flow Wire set up count
 camp make Just soft and economy of

Give space a personal definition

Simple styling elements, charming streamlined lighting,
Presenting the beauty of simplicity



With each step, light suddenly appears

Design inspired by life
Streamlined and simple lighting design
Create your own lighting space





Minimalist style without main light

Clean lines, simple styling
Give space unlimited changes and imagination

Achieve "extraordinary" by "not being complicated"

Simple shape and neat lines follow the principle of "less is more"
The minimalist design concept uses light and shadow to outline the order and beauty of the space. Showcasing the simple beauty of Nordic design to its fullest



Installation Notes

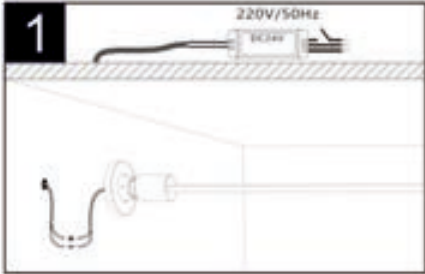

Reserve the power supply line at the installation location and connect the power supply line. Lamp, connect it to DC24V voltage, turn on the switch, and try On, make sure the circuit is smooth.

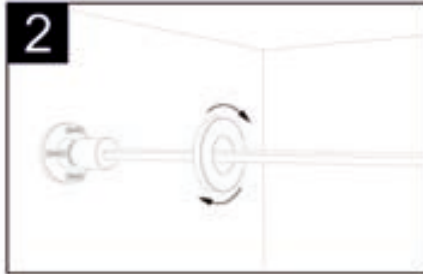

Unscrew the end cover and use the screws to secure both ends of the lamp to the ceiling. The plate is fixed.
Note : fixed rail



After installing the track, screw the top cover back to the ceiling plate; use a hexagonal key to tighten the machine screws on the ceiling plate to secure the tension head (this machine meter is used to control of the tension head. If you find that angle cannot be adjusted before installation, you can loosen the screws of the machine meter)



After installing the track, use the rotating piece on the tension head to straighten the track. When rotating, hold the track to prevent the line from being twisted due to synchronous rotation of the track (both ends can lengthen the track by about 40mm); install the lamp and turn on the switch. Test light.

Note : When rotating the puling head, erure that the track is straightened and dent pullagan forcefully to abiding hit steel wire in the track, break.





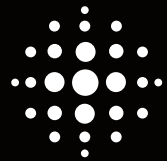

CATERLUX
Live an illuminated life



E-mail : info@caterlux.co.in
Website : www.caterlux.co.in

